

Soft Flex Neon Light



Model : SLB-1515-24V

Features:

- Exceptional even illumination & dotless
- 100% unbreakable
- 100% waterproof
- Easy installation with aluminium trough

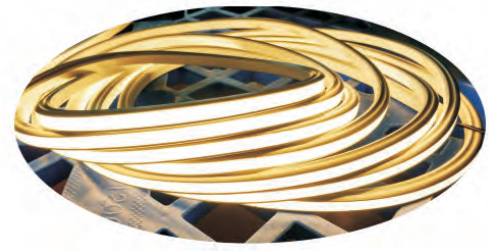

Model : SLB-1515-24V

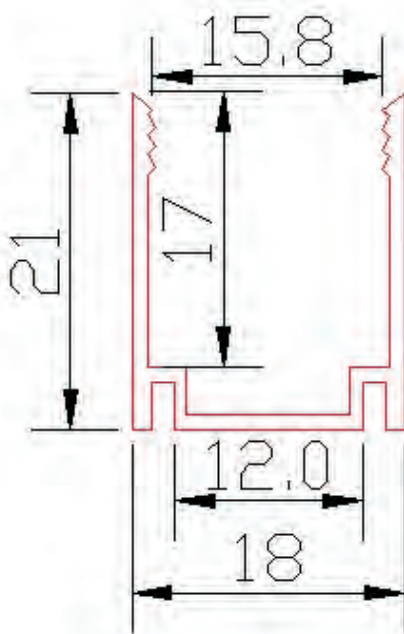

Standard

Standard Size(mm)	15mm(W)*15mm(H)
Voltage (V)	DC24V
Cover Material	Silicon
Length per roll	5M
Power per M	10.8W
LED emitting side	Top view
Bending direction	up/down
CRI	>80Ra
Luminous Efficacy	70 lm/W
Total Lumen	756lm/M
LED Nos	84PCS/M
Power Factor	> 0.90
LED Color Temperature	White(6000K) Red,Amber,Orange,Blue or Green
Minimum cutting width	84mm
Rating	IP 66

LED Flex Neon Light

Model : SLB-1117-24V

Features:

- Exceptional even illumination & dotless
- 100% unbreakable
- 100% waterproof
- Easy installation with aluminium trough

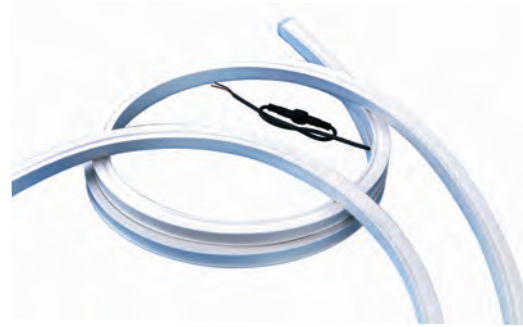

Model : SLB-1117-24V

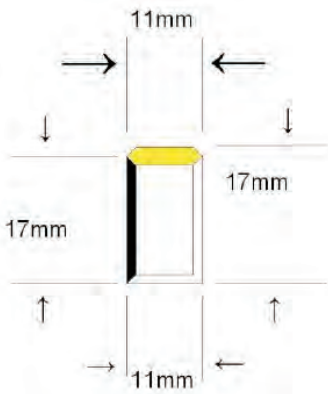

Standard

Standard Size(mm)	11mm(W)*17mm(H)
Voltage (V)	DC24V
Cover Material	Silicon
Length per roll	5M
Power per M	12W
LED emitting side	side view
Bending direction	left/right
CRI	>80Ra
Luminous Efficacy	70 lm/W
Total Lumen	840lm
LED Nos	84PCS/M
Power Factor	> 0.90
LED Color Temperature	White(6000K) Red,Amber,Orange,Blue or Green
Minimum cutting width	84MM
Rating	IP 66



Side view

LED Flex Neon Light

Model : SLB-1526-24V

Features:

- Exceptional even illumination & dotless
- 100% unbreakable
- 100% waterproof
- Easy installation with aluminium trough

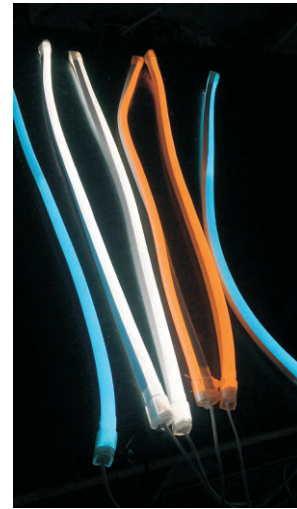

Model : SLB-1526-24V

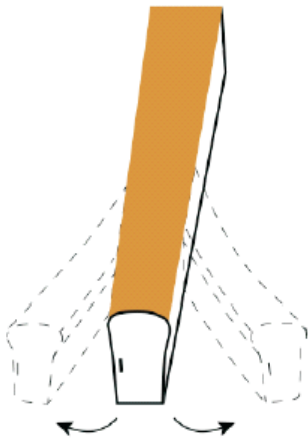

Standard

Standard Size(mm)	15mm(W)*26mm(H)
Voltage (V)	DC24V
Cover Material	PVC
Length per roll	Customizable
Power per M	9W
LED emitting side	side view
Bending direction	left right
CRI	>80Ra
Luminous Efficacy	34 lm/W
Total Lumen	300lm
LED Nos	60PCS/M
Power Factor	> 0.90
LED Color Temperature	White(6000K) Warm white(3000K)
Minimum cutting width	100mm
Rating	IP 65

LED Light Belt

Model : SLB-S5050-12V

Features:

1. High brightness patch 5050 LED is adopted as the light source with high brightness and wide Angle of view
2. Ultra-low power consumption, only 0.6 watts per unit
3. Reasonable optical design, no light spots, good brightness consistency
4. The base plate adopts double-sided imported calender copper FPC, which has good folding resistance and strong over-current capacity
5. Low voltage DC12V constant voltage drive, safe and stable



Model : SLB-S5050-12V

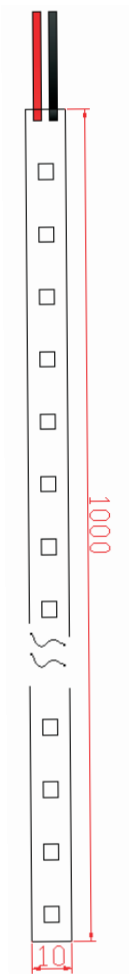
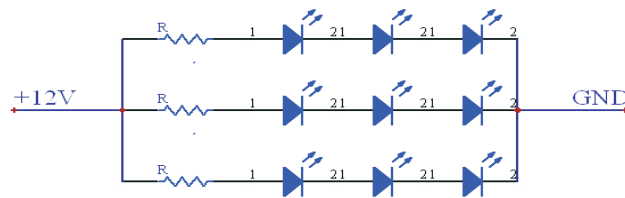

Standard

Standard Size(mm)	10mm(W)*3.5mm(H)
Voltage (V)	DC12V
Cover Material	FPC
Length per roll	5M
Power per M	14W
CRI	>80Ra
Luminous Efficacy	80 lm/W
Total Lumen	1120lm
LED Nos	60PCS/M
Power Factor	> 0.90
LED Color Temperature	3000K
Minimum cutting width	0.5M